



Copyright © 2017 by BTECH; <https://baofengtech.com>

All rights reserved. No part of this publication may be reproduced, distributed, or transmitted in any form or by any means, including photocopying, recording, or other electronic or mechanical methods, without the prior written permission of the publisher, except in the case of brief quotations embodied in critical reviews and certain other noncommercial uses permitted by copyright law. For permission requests, write to the publisher.

Contributions taken from: Miklor.com Resource Site, and Jim Unroe, KC9HI. Used by permission. All rights reserved.

**THANK YOU FOR YOUR PURCHASE OF THE BTECH: UV-25X2, UV-25X4, or UV-50X2. THIS MULTI-BAND RADIO WILL DELIVER INSTANT RELIABLE COMMUNICATION.**

**PLEASE READ THIS MANUAL CAREFULLY BEFORE USE**

---

## Table of Contents

<b>Part I. Getting started</b>	<b>1</b>
<b>Chapter 1. – Getting Started</b>	<b>2</b>
Unpacking and Inspecting	3
UV-25X2: Overview of the Front Panel	4
UV-25X4: Overview of the Front Panel	6
UV-50X2: Overview of the Front Panel	8
UV-25X2 & UV-25X4: Overview of the Rear Ports	10
UV-50X2: Overview of the Rear Ports	12
Hand Held Mic Keys and Description	14
Color Display and Icon Descriptions	15
<b>Antenna Basics</b>	<b>17</b>
Grounding Plane:	17
Antenna Requirements	18
<b>Chapter 2. – Basic Shortcuts and Use</b>	<b>19</b>
Pound # Key	19
Star * Key	19

---

Turning the unit on	20
Turning the unit off	20
Adjusting the volume	20
<b>Making a call</b>	<b>21</b>
<b>Channel selection</b>	<b>21</b>
Frequency (VFO) mode	21
Channel (MR) mode	22
<b>Monitor Both VFO &amp; MR Modes</b>	<b>23</b>
<b>Chapter 3. – Menu Quick Review</b>	<b>24</b>
<b>Quick Menu Settings</b>	<b>24</b>
<b>Chapter 4. – Programming</b>	<b>32</b>
<b>Frequency Mode vs. Channel Mode</b>	<b>32</b>
<b>Ex: Programming a Channel Repeater Offset with CTCSS Tone</b>	<b>33</b>
<b>Ex. Programming a Simplex Channel with CTCSS tone</b>	<b>34</b>
<b>Chapter 5. – Other Settings</b>	<b>35</b>
Toggle from High to Low Power	35
Storing an FM Radio Station and Scanning	35
Keypad Lock-out	35
PTT ID Setting	35

---

DTMF RX Settings	36
DTMF TX Settings	36
Remote Stun	37
Remote Kill	38
Remote Revive	38
Read More About Remote Commands	39
DTMF Receive Settings, Transmit Setting (Call Key)	39
2TONE Receive Settings, Transmit Setting (Call Key)	39
5Tone Receive Settings, Transmit Setting (Call Key)	40
<b>Scanning modes</b>	<b>41</b>
Time operation	41
Carrier operation	41
Search operation	42
<b>SKIP Scanning Channels</b>	<b>42</b>
<b>Scanning a Frequency Range (VFO Mode)</b>	<b>42</b>
<b>Tone Scanning</b>	<b>43</b>
Scanning for CTCSS and DCS Tones/Codes	43
<b>Dual, Tri, and Quad Watch (TMR)</b>	<b>46</b>
<b>Chapter 6. - Selective calling</b>	<b>48</b>
CTCSS	49

---

DCS	50
1000Hz, 1450Hz, 1750Hz, 2100Hz Tone-burst	52
<b>Part III. How-to and setup guides.</b>	<b>53</b>
<b>Chapter 7. - Repeaters</b>	<b>54</b>
<b>Chapter 8. - Application Specific Setup</b>	<b>57</b>
Commercial Radio Setup	57
Amateur Radio Setup	58
FRS, GMRS, MURS, PMR446	58
<b>Chapter 9. - Customization</b>	<b>60</b>
Display	60
Sync Display Channels	62
<b>Appendix A. - Menu definitions</b>	<b>64</b>
<b>Appendix B. - Technical specifications</b>	<b>74</b>
General	74
Receiver	75
Transmit	75



# Part I. Getting started

*Part one covers the basic setup and use of your mobile two-way transceiver.*

**CHAPTER 1 GETTING STARTED**

**CHAPTER 2 BASIC USE**

**CHAPTER 3. – MENU QUICK REVIEW**

**CHAPTER 4. – PROGRAMMING**

**CHAPTER 5. – OTHER SETTINGS**



# Chapter 1. – Getting Started

## BEFORE PROCEEDING INSURE:

- Qualified technicians shall service this equipment only. Do not modify the radio for any reason.
- Use only BTECH supplied or approved accessories.
- **Turn off your radio prior to entering any area with explosive and flammable materials. Do NOT USE your transceiver at a gas/fuel station**
- For vehicles with an air bag, do not mount your radio in the area over an air bag or in the air bag deployment area.
- Do not expose the radio to direct sunlight over a long time, nor place it close to a heating source.
- If the unit emits smoke or an odor, you should immediately cut off the power supply. Then send the radio to the nearest service center or dealer
- Do not operate the mobile transceiver on high power unless it is necessary. Do not transmit for long periods of time, as it may overheat the transceiver.
- Keep the unit away from dusty, damp and wet environments
- Use the correct power supply (~13.8V); do not use incorrect or higher voltage (e.g. 24V)

# Unpacking and Inspecting

- Please check the packaging of your radio for any signs of damage.
- Carefully open the box, and confirm you received the items listed below.
- If you find the radio or the included accessories are damaged or lost, immediately contact your dealer.

## What's in the Box



UV-25X4



UV-50X2

\*\*UV-25X2 (Not Pictured)

Mobile Radio

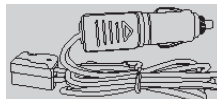

UV-25X4/UV-25X2\*

or

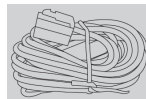

UV-50X2\*\*

\* Power Cable (Cig Adapter for UV-25X2,UV-25X4)

\*\* Power Cable (Direct Connect for UV-50X2)



Microphone



Mounting Screws  
and Fuse

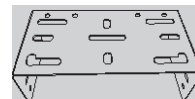

Mounting Bracket

## UV-25X2: Overview of the Front Panel

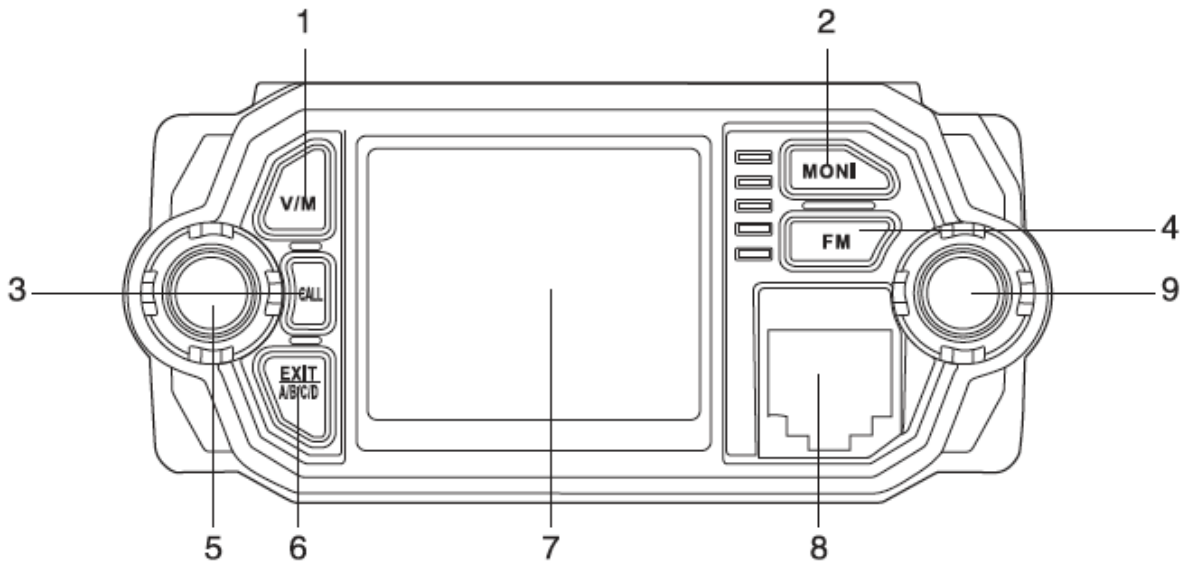

1. V/M Mode Switch  
(Channel/Frequency)
2. Monitor function
3. Call key
4. FM radio function key
5. Power, On/Off Press + Volume Knob
6. Exit Menu + A/B/C/D signal switching  
+ alarm function
7. Display screen
8. Microphone Connector
9. Confirm Key Press +Main Selector  
(Menu Knob)

**CALL**: when in standby, press to send caller ID (ANI) in the selected signaling mode; while transmitting, press to send activate signaling.

**MONI**: press to turn on the squelch, repeat to turn off the squelch.

**V/M**: press to switch between channel mode and frequency mode.

**EXIT ABCD**: press to choose between A,B,C, or D frequencies --- Or exit function mode.

**FM**: press to enter and exit FM radio

## RJ45 Connector:

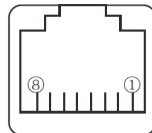

- |              |              |
|--------------|--------------|
| ① Data Input | ⑤ PTT.       |
| ② RPT CTRL   | ⑥ GND        |
| ③ MIC        | ⑦ +8V DC Out |
| ④ MIC Ground | ⑧ Null       |

## UV-25X4: Overview of the Front Panel

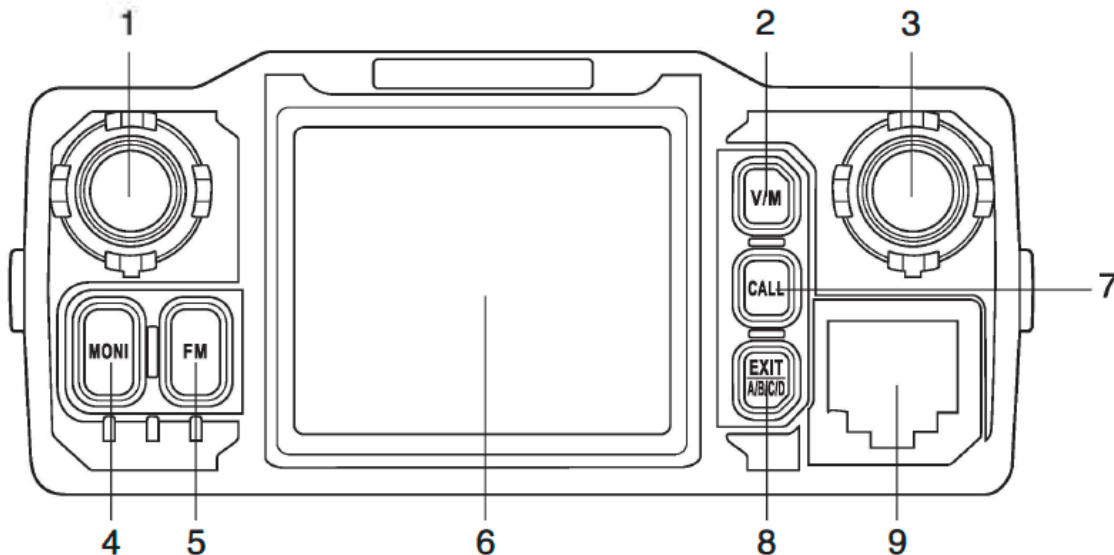

1. Power, On/Off Press + Volume Knob
2. V/M Mode Switch  
(Channel/Frequency)
3. Confirm Key Press +Main Selector  
(Menu Knob)
4. Monitor function
5. FM radio function key
6. Display screen
7. Call key
8. Exit Menu + A/B/C/D signal switching  
+ alarm function
9. Microphone Connector

**CALL** : when in standby, press to send caller ID (ANI) in the selected signaling mode; while transmitting, press to send activate signaling.

**MONI** : press to turn on the squelch, repeat to turn off the squelch.

**V/M** : press to switch between channel mode and frequency mode.

**EXIT ABCD** : press to choose between A,B,C, or D frequencies --- Or exit function mode.

**FM** : press to enter and exit FM radio

## RJ45 Connector:

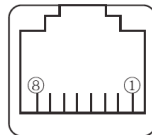

- |              |              |
|--------------|--------------|
| ① Data Input | ⑤ PTT.       |
| ② RPT CTRL   | ⑥ GND        |
| ③ MIC        | ⑦ +8V DC Out |
| ④ MIC Ground | ⑧ Null       |

## UV-50X2: Overview of the Front Panel

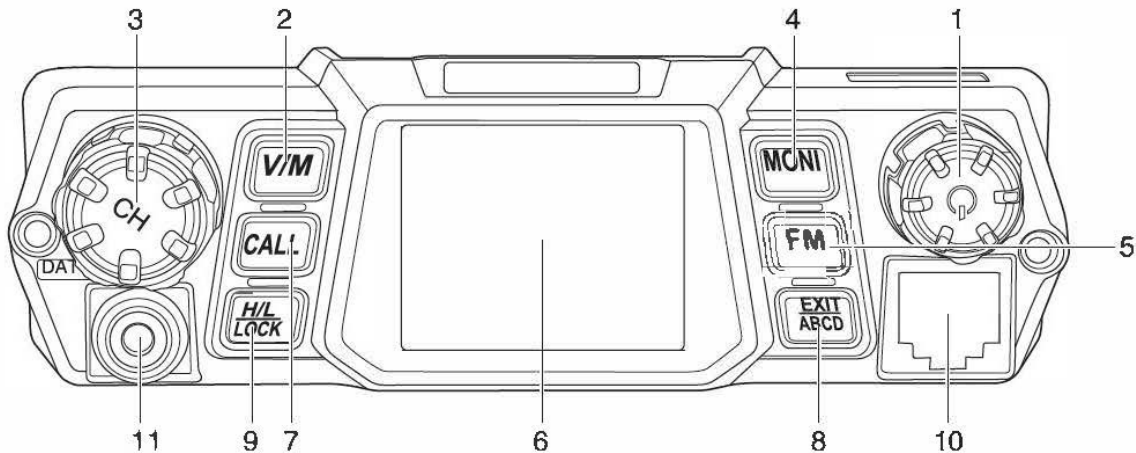

1. Power, On/Off Press + Volume Knob
2. V/M Mode Switch  
(Channel/Frequency)
3. Confirm Key Press +Main Selector  
(Menu Knob)
4. Monitor function
5. FM radio function key
6. Display screen
7. Call key
8. Exit Menu + A/B/C/D signal switching  
+ alarm function
9. High / Lower Power Switch + Lock
10. Microphone Connector
11. DATA, Programming Jack: PC-04  
Programming Cable Jack

**CALL** : when in standby, press to send caller ID (ANI) in the selected signaling mode; while transmitting, press to send activate signaling.

**MONI** : press to turn on the squelch, repeat to turn off the squelch.

**V/M** : press to switch between channel mode and frequency mode.

**EXIT ABCD** : press to choose between A,B,C, or D frequencies --- Or exit function mode.

**FM** : press to enter and exit FM radio

**H/L LOCK** : press to toggle high/lower power ; hold to key-lock/or key-unlock

## RJ45 Connector:

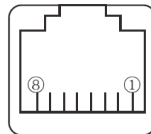

- |              |              |
|--------------|--------------|
| ① Data Input | ⑤ PTT.       |
| ② RPT CTRL   | ⑥ GND        |
| ③ MIC        | ⑦ +8V DC Out |
| ④ MIC Ground | ⑧ Null       |



## UV-25X2 & UV-25X4: Overview of the Rear Ports

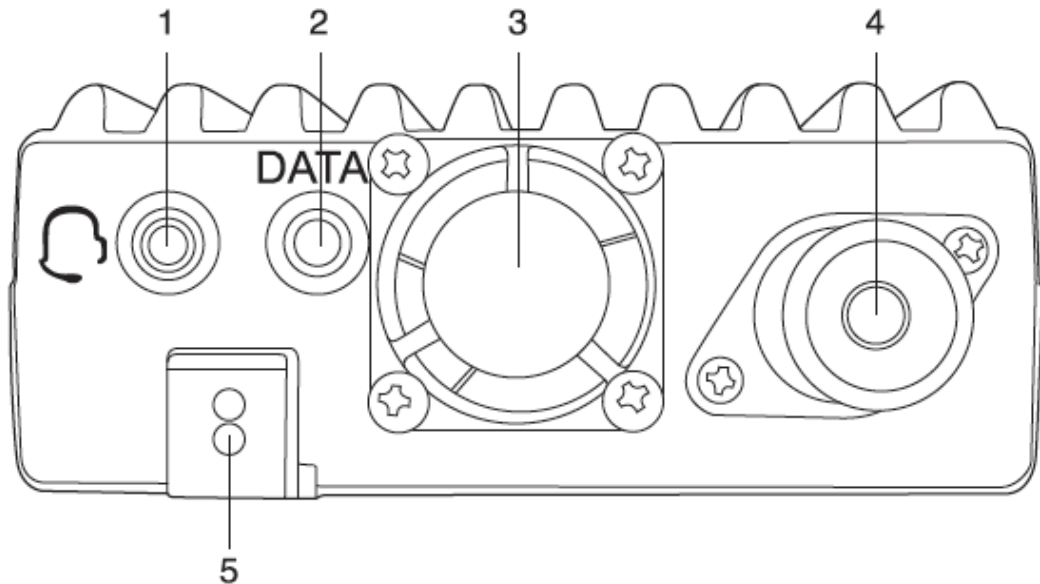

1. TRRS Line Out: Includes PTT/Microphone/Audio-out/GND
2. DATA, Programming Jack: PC-04 Programming Cable Jack
3. Cooling Fan
4. SO-239 RF Antenna Connector: Connects to PL-259 Antennas
5. DC Power Input (13.8V – 7A Peak)

#### TRRS Line-Out Connector:.

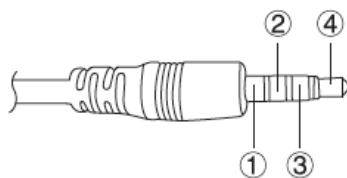

- ① GND
- ② SP
- ③ MIC
- ④ PTT

### Programming Cable:

PC-04 Cable available at: [www.baofengtech.com/accessories](http://www.baofengtech.com/accessories)

Programming software available at: [www.baofengtech.com/download](http://www.baofengtech.com/download)

## UV-50X2: Overview of the Rear Ports

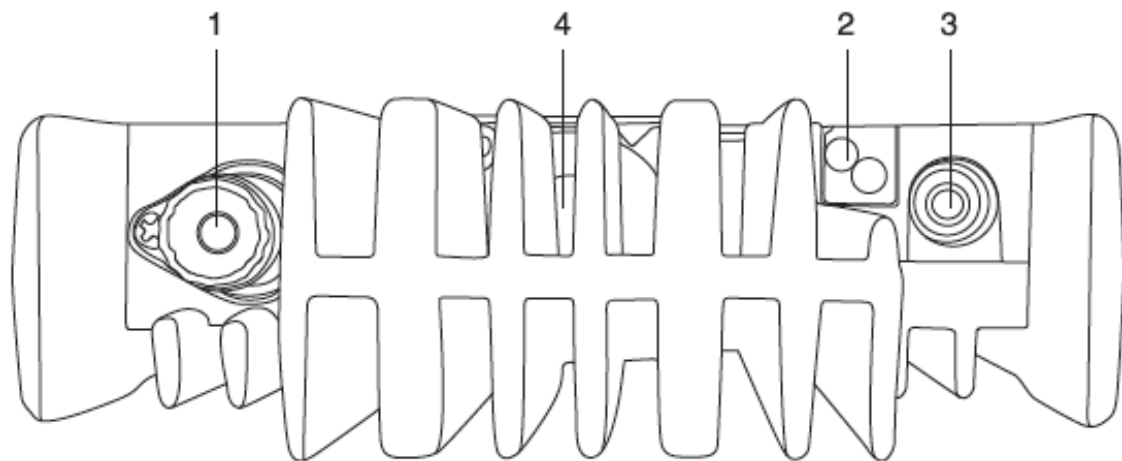

1. SO-239 RF Antenna Connector:  
Connects to PL-259 Antennas
2. DC Power Input (13.8V – 20A Peak)
3. TRRS Line Out: Includes  
PTT/Microphone/Audio-out/GND
4. Cooling Fan

#### TRRS Line-Out Connector:.

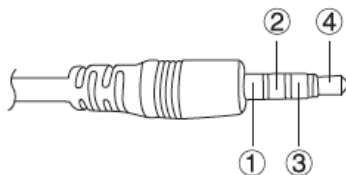

- ① GND
- ② SP
- ③ MIC
- ④ PTT

## Programming Cable:

PC-04 Cable available at: [www.baofengtech.com/accessories](http://www.baofengtech.com/accessories)

Programming software available at: [www.baofengtech.com/download](http://www.baofengtech.com/download)

# Hand Held Mic Keys and Description

- 1 "MENU": Function key  
**VFO/MR Toggle (Long Press)**
- 2 "UP": Higher frequency
- 3 "DOWN": Lower frequency
- 4 "EXIT": Exit the AB channel switch, alarm function  
**Alarm Activate (Long Press)**
- 5 "\* / SCAN": Scanning function
- 6 "# / LOCK": High / Low Power Toggle  
**Keyboard Lock (Long Press)**
- 7 "0": Number 0
- 8 "1": Number 1
- 9 "2": Number 2
- 10 "3": Number 3
- 11 "4": Number 4
- 12 "5": Number 5
- 13 "6": Number 6
- 14 "7": Number 7
- 15 "8": Number 7
- 16 "9": Number 9

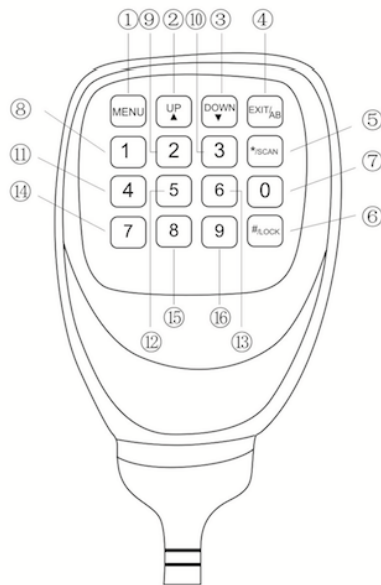

# Color Display and Icon Descriptions

The Top Line on the LCD will show the current selected channel's settings at a glimpse:

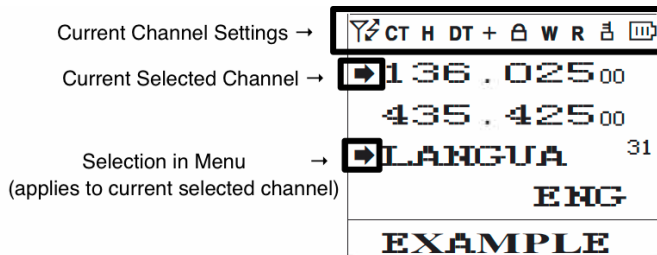

Icon	Description	Icon	Description	Icon	Description
	Channel allowed to TX and RX	<b>DCS</b>	DCS Enabled (TX,RX or Both)	<b>+</b>	Positive Offset (Freq. Mode)
	Channel allowed to RX Only	<b>L</b>	Transmit Power: Low	<b>-</b>	Negative Offset (Freq. Mode)
	Channel allowed to TX Only	<b>H</b>	Transmit Power: High	<b>±</b>	Offset Enabled (Chan. Mode)
	Channel disabled to TX or RX	<b>2T</b>	2Tone Calling Enabled	<b>N</b>	Channel set to Narrowband
	Keypad is Locked	<b>5T</b>	5Tone Calling Enabled	<b>W</b>	Channel set to Wideband
<b>CT</b>	CTCSS Enabled (TX,RX or Both)	<b>DT</b>	DTMF Calling Enabled	<b>R</b>	Channel Reverse Enabled
	Battery Strength (Weak Battery Indicator)				

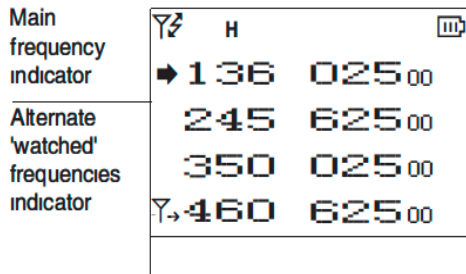

Dual, Tri, or Quad Watch selected in "Menu 0:TMR"

Custom Boot Message -  
editable via  
PC  
Programming

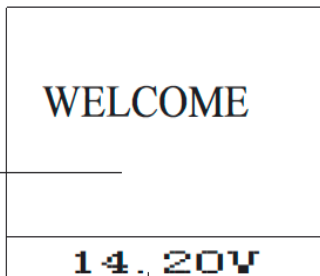

Current Voltage  
detected from the  
power source

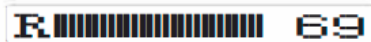

Strength Meter for the  
incoming signal

Numerical scale  
for the incoming  
transmission  
intensity



Meter for the transmit  
output power - (High  
or Low Power  
Indicator)

Numerical scale  
for microphone  
transmit audio  
level intensity



Microphone  
transmit audio  
level intensity

# Antenna Basics

Your Mobile Radio Kit does not include an Antenna. It is VERY Important to NOT transmit without a antenna or dummy load attached to the mobile radio. Doing so, will cause harm to the internal components of your radio.

You will want to choose a suitable antenna for the bands you plan on transmitting and receiving on. If you plan on transmitting on 145MHz you will want to ensure you have picked an antenna that states it is capable of working with 145MHz. If an antenna is not properly tuned for the frequency you transmit on – it can cause damage with the reflected power going back into the radio.

Pick an antenna with SWR of less than 1.5:1 to safely transmit.

## Grounding Plane:

Antennas require an appropriate grounding plane to properly work:

## Magnetically Mounted Antennas:

These antennas must be grounded to a metal surface, such as a vehicle body. Magnetic base antennas do not properly operate unless they are fully magnetically grounded first.



## NMO or PL-259 Base Antennas:

These antennas will normally require a base or mobile hardware kit. These kits are grounded either through: drill or clamp inserts on vehicles, magnetically mounted, or available as stationary base hardware kits. Some antennas may include a base station grounding plane kit.

## Antenna Requirements

Antenna SWR Rating: 1.5:1 or less (on the radio frequencies in use.)

Antenna Impedance: 50 ohm (use 50 ohm rated coax and coax connectors)

Antenna Grounding: Ensure the antenna is mounted with a grounding plane

Visually Inspect Coax/Connectors for any Slits or Damage – moisture should not be allowed to penetrate fittings or your coax

To maximize the life of your radio, it is important to understand antenna basics before transmitting on your radio, transmitting without an antenna, or with high SWR (Standing Wave Ratio) – can void warranty support.

An Active SWR Meter is a great tool to have when selecting an antenna for your needs. You can monitor and confirm that your SWR is within safe levels when setting up your radio for the first time (periodically checking SWR and your antenna set-up is advised)

## Chapter 2. – Basic Shortcuts and Use

### Pound # Key

#### Keypad Lock

To enable or disable the keypad lock, press and hold the  key for about two seconds.

A quick toggle of the # will alternate power levels from High power to Low power

The keypad lock will lock both the main radio buttons itself and also the handheld keypad.

The PTT/MONI/and Power Buttons will not be locked when enabled.

### Star \* Key

A short momentary press of the key enables the reverse function (reverses the TX/RX settings according to Offset settings)

When listening to broadcast FM a momentary press will start the scanning. Scanning in broadcast FM will stop as soon as an active station is found

To enable scanning, press and hold the  key for about two seconds

## Turning the unit on

To turn the unit on, simply push and hold the volume knob until it turns on. If your radio powers on correctly there should be an audible tone after about one second and the display will show a message or flash the LCD depending on settings

## Turning the unit off

To turn the unit off, simply push and hold the volume knob until it turns off. The unit is now off.

## Adjusting the volume

To turn up the volume, turn the volume knob clock-wise.

To turn the volume down, turn the volume/power knob counter-clock-wise.



*By using the monitor function (MONI button), you can more easily adjust your volume by adjusting it to the un-squelched static.*

## Making a call

Press and hold the PTT button on the side of the handheld mic to transmit. While transmitting, speak approximately 3-5cm (1-2 inches) from the microphone. When you release the PTT your transceiver will go back to its receive mode.

## Channel selection



There are two modes of operation: Frequency (VFO) mode, and Channel or Memory (MR) mode.

For everyday use, Channel (MR) mode is going to be a whole lot more practical than Frequency (VFO) mode. However, Frequency (VFO) mode is very handy for experimentation out in the field.

Frequency (VFO) mode is also used for programming channels into memory. For details on how to program your transceiver see Chapter 4, *Programming*.

Ultimately which mode you end up using will depend entirely on your use case.

### Frequency (VFO) mode

In Frequency (VFO) mode you can navigate up and down the band by using the  and  keys (or rotating the selector knob). Each press (or rotation click) will increment or decrement your frequency according to the frequency step you've set your transceiver to (Menu Item 1: Step)

You can also input frequencies directly on your numeric keypad with kilohertz accuracy. However, the radio will floor to the nearest frequency that corresponds to your frequency step, in other words, when you input frequencies with greater than 1kHz resolution (such as 145.6875 MHz in the example below), always round your input up.

*Just because you can program in a channel does not mean you're automatically authorized to use that frequency.*





*Transmitting on frequencies you're not authorized to operate on is illegal, and in most jurisdictions a serious offence. If you get caught transmitting without a license you can and will get fined, and in worst case sent to jail.*

*However, it is legal in most jurisdictions to listen. Contact your local regulatory body for further information on what laws, rules and regulations apply to your area.*

## Channel (MR) mode

The use of Channel (MR) mode is dependent on actually having programmed in some channels to use. To find out more on how to program channels see Chapter 4, *Programming*.

Once you have channels programmed and ready, you can use the  and  keys to navigate between channels (or Rotate the Selector Knob)



*If you have channels programmed with Transmit power set to Low, you can use the  key to momentarily switch over to high power if you're having trouble getting through.*

## Monitor Both VFO & MR Modes

You can toggle from VFO and MR (Memory Recall) mode by either pressing the V/M button on the front of your radio, or you can toggle modes from the Handheld Mic by a long press of the 'Menu' button.

The VFO/MR mode will only toggle on the current selected A/B/C/D line – while the other channel lines will remain on channel or memory mode as they were selected.

**This allows you to monitor channel and frequency mode simultaneously**

# Chapter 3. – Menu Quick Review

## Quick Menu Settings

*(Full Definitions in Appendix A)*

*To set the Menu options from the Mobile body use the M Press the selector knob on the radio body (or the Menu Key on the microphone) to select and confirm the changes, while rotating the selector knob (or using the microphone arrow keys) will change your settings.*

0. **[Enter Menu]+ [0]** : TMR – This mode selects what displays are monitored in the background besides the primary selected channel. You can mix and match between all or partial channels to allow dual, tri, or quad watch
1. **[Enter Menu]+ [1]** : STEP – set the frequency increments step in VFO mode: 2.5kHz, 5kHz, 6.25kHz, 10kHz, 12.5kHz, 25kHz selectable.
2. **[Enter Menu]+ [2]** : SQL – Sets the receiver squelch level: 0 is OFF, 1 is the lowest setting through 9 which is the highest setting.
3. **[Enter Menu]+ [3]** : TXP – Sets the transmit power setting from HIGH to LOW.
4. **[Enter Menu]+ [4]** : AUTOLK – Keypad auto-lock setting. This activates the keypad auto-lock feature, which lock the keypad after 8 seconds of no use; pressing the # key for 2 seconds

will release the auto lock.

5. **[Enter Menu]+ [5]** : TOT - transmission time-out timer. Sets the maximum transmit time from 15 to 600 seconds (15 second steps).
6. **[Enter Menu]+ [6]** : APO – Auto Power Off powers off the radio after a predetermined time with no receiver activity. (30 > 300 minutes)
7. **[Enter Menu]+ [7]** : WN - WIDE or NARROW band width settings (12.5/25khz).
8. **[Enter Menu]+ [8]** : ABR – Unused Setting
9. **[Enter Menu]+ [9]** : BEEP - turns key beeps OFF or ON.
10. **[Enter Menu]+ [1] + [0]** : R-DCS - DCS receive/squelch settings. Options include the D023N-D754N positive sequence and the D023I- D754I reversed sequence.
11. **[Enter Menu]+ [1] + [1]** : R-CTCS - CTCSS receive/squelch settings. Selectable from 67.0HZ-254.1HZ. you can use the keypad to quickly enter in the desired setting
12. **[Enter Menu]+ [1] + [2]** : T-DCS - DCS transmit settings. Options include the D023N-D754N positive sequence and the D023I- D754I reversed sequence.
13. **[Enter Menu]+ [1] + [3]** : T-CTCS CTCSS transmit settings. Selectable from 67.0HZ-254.1HZ. you can use the keypad to quickly enter in the desired setting
14. **[Enter Menu]+ [1] + [4]** : DTMFST – DTMF transmit tone settings.  
**OFF:** No tones heard through the speaker when transmitting. **KEY:** Only manually keyed DTMF codes are heard. **ANI:** Only automatically keyed DTMF codes are heard. **BOTH:** All DTMF codes are heard.
15. **[Enter Menu]+ [1] + [5]** : BCL - busy channel lock- out. If you have this turned on the



- transmitter will not transmit if a channel is receiving at the time
16. **[Enter Menu]+ [1] + [6]** : SC-ADD - scan settings. OFF: This removes the channel from the scan list. ON: This adds the channel to scanning list.
  17. **[Enter Menu]+ [1] + [7]** : SC-REV – Scanning settings. TO: time out scan, after the stopping on an active signal, scanning will resume after a few seconds. CO: Scanning will stop on a carrier channel and will resume after the carrier channel stops receiving SE: Scanning will stop once an active carrier channel is found.
  18. **[Enter Menu]+ [1] + [8]** : OPTSIG – Turn on the optional signaling. OFF the channel or mode will not use optional signaling DTMF: DTMF signaling required. 2TONE: 2 tone signaling required. 5TONE: 5 tone signaling required. (PC programming is required to specify the DTMF, 2Tone, and 5Tone settings)
  19. **[Enter Menu]+ [1] + [9]** : SPMUTE – Squelch settings when combining standard and optional tones. QT: The squelch will open for just a CTCSS or DCS Receive tone. AND: This requires both the optional tone settings (Menu 20) and CTCSS/DCS settings to be received. OR: If a either the DCS/CTCSS or optional signaling is received the squelch will open
  20. **[Enter Menu]+ [2] + [0]** : PTT-ID - PTT-ID transmit setting. OFF: no ID code sent when transmitting. BOT: send ID code at Beginning of Transmit. EOT: send ID code at End of Transmit. BOTH: send ID code at both beginning and end of transmit. (PTTID code information can only be set by the PC software)
  21. **[Enter Menu]+ [2] + [1]** : PTT-LT - PTT-ID transmit delay setting. (Delay Time range is 0-30 seconds.). This is the delay time before transmitting the PTTID

22. **[Enter Menu]+ [2] + [2]** : S-INFO - Signal information and automatic dialing memory. 1-15 group signal code/decode memory. The memory list is programmed through software.
23. **[Enter Menu]+ [2] + [3]** : EMC-TP - alarm mode settings. ALARM: turns on the alarm sound on the device itself. ANI: Sends the Alarm and PTTID through the Transmitter. BOTH: combines both of the options above. OFF: Disables alarm
24. **[Enter Menu]+ [2] + [4]** : EMC-CH - alarm channel setting. This is the channel that the alarm will transmit the PTTID and Alarm sound on
25. **[Enter Menu]+ [2] + [5]** : SIG-BP – Pager Ring at Reception of Matching 2Tone/5Tone/DTMF (on/off)
26. **[Enter Menu]+ [2] + [6]** : CHNAME - channel name edit.
27. **[Enter Menu]+ [2] + [7]** : CA-MDF - Display Mode (Display A) - FREQ: displays Frequency. CH: displays channel number. NAME: displays assigned channel name.
28. **[Enter Menu]+ [2] + [8]** : CB-MDF - Display Mode (Display B) - FREQ: displays Frequency. CH: displays channel number. NAME: displays assigned channel name.
29. **[Enter Menu]+ [2] + [9]** : CC-MDF - Display Mode (Display C) - FREQ: displays Frequency. CH: displays channel number. NAME: displays assigned channel name.
30. **[Enter Menu]+ [3] + [0]** : CD-MDF - Display Mode (Display D) - FREQ: displays Frequency. CH: displays channel number. NAME: displays assigned channel name.
31. **[Enter Menu]+ [3] + [1]** : LANGUA – Language Display Mode (English or Chinese)
32. **[Enter Menu]+ [3] + [2]** : SYNC – With this 2 Channel lines can be synched together (A+B, C+D, A+B and C+D) (use in conjunction with Menu 27 through 30 to display the channel

- name and frequency simultaneously)
33. **[Enter Menu]+ [3] + [3]** : MAINFC – Main LCD Display Foreground, Text Color: Color options are BLACK, WHITE, RED, BLUE, GREEN, YELLOW, INDIGO, PURPLE, GRAY
  34. **[Enter Menu]+ [3] + [4]** : MAINBC Main LCD Display Background Color: Color options are BLACK, WHITE, RED, BLUE, GREEN, YELLOW, INDIGO, PURPLE, GRAY
  35. **[Enter Menu]+ [3] + [5]** : MENUFC - Menu LCD Display Foreground, Text Color: Color options are BLACK, WHITE, RED, BLUE, GREEN, YELLOW, INDIGO, PURPLE, GRAY.
  36. **[Enter Menu]+ [3] + [6]** : MENUBC - Menu LCD Display Background Color: Color options are BLACK, WHITE, RED, BLUE, GREEN, YELLOW, INDIGO, PURPLE, GRAY
  37. **[Enter Menu]+ [3] + [7]** : STA-FC – Status Bar LCD Display Foreground, Text Color: Color options are BLACK, WHITE, RED, BLUE, GREEN, YELLOW, INDIGO, PURPLE, GRAY
  38. **[Enter Menu]+ [3] + [8]** : STA-BC - Status Bar LCD Display Background Color: Color options are BLACK, WHITE, RED, BLUE, GREEN, YELLOW, INDIGO, PURPLE, GRAY
  39. **[Enter Menu]+ [3] + [9]** : SIG-FC – Signal Bar LCD Display Foreground, Text Color: Color options are BLACK, WHITE, RED, BLUE, GREEN, YELLOW, INDIGO, PURPLE, GRAY
  40. **[Enter Menu]+ [4] + [0]** : SIG-BC - Signal Bar LCD Display Background Color: Color options are BLACK, WHITE, RED, BLUE, GREEN, YELLOW, INDIGO, PURPLE, GRAY
  41. **[Enter Menu]+ [4] + [1]** : RX-FC Receive Active Channel Foreground, Text Color: Color options are BLACK, WHITE, RED, BLUE, GREEN, YELLOW, INDIGO, PURPLE, GRAY
  42. **[Enter Menu]+ [4] + [3]** : TX-FC - Transmit Active Channel Foreground, Text Color: Color options are BLACK, WHITE, RED, BLUE, GREEN, YELLOW, INDIGO, PURPLE, GRAY

43. **[Enter Menu]+ [4] + [3]** : Transmit Display – Status Bar Numerical Display Options (Power Level or Mic Level)
44. **[Enter Menu]+ [4] + [4]** : MEM-CH - saves the selected channel.
45. **[F Key} + [4] + [5]** : DEL-CH - deletes the selected channel
46. **[Enter Menu]+ [4] + [6]** : SFT-D - Frequency difference direction setting. OFF: no frequency difference. (+): Transmit offset amount will be a positive offset (higher than the receive frequency). (-): Transmit offset will be a negative offset (amount will be lower than the receive frequency).
47. **[Enter Menu]+ [4] + [7]** : OFFSET - difference between the transmit and receive frequency.
48. **[Enter Menu]+ [4] + [8]** : ANI – Displays the radio ID code. Code only can set by PC software.
49. **[Enter Menu]+ [4] + [9]** : ANI-L - ID code length. Length = 3, 4, 5.
50. **[Enter Menu]+ [5] + [0]** : REP-S – Tone burst repeater settings. Pressing CALL will send a predetermined tone. Options are 1000 Hz, 1450 Hz, 1750 Hz, 2100 Hz.
51. **[Enter Menu]+ [5] + [1]** : REP-M - repeater forwarding mode setting. Used in conjunction with two radios connected as a repeater. **OFF**: turned off. **CARRI**: forwards after it receives a carrier call. **CTDCS**: forwards after it receives correct CT/DCS tone **TONE**: forwards after it receives the correct 2Tone or 5Tone. **DTMF**: forwards after it receives the assigned DTMF code.
52. **[Enter Menu]+ [5] + [2]** : TMR-MR – Transmit Delay Return time. Delay time before

- returning to the primary channel after the secondary signal is clear. (PTT Return Time)
53. **[Enter Menu]+ [5] + [3]** : STE - Squelch Tail Elimination at the end of a received signal. Requires both transmitting radios to have the option ON.
  54. **[Enter Menu]+ [5] + [4]** : RP-STE - Repeater Squelch Tail Elimination requires a repeater with this function ON. (Reverses the CT/DCS settings at the end of a transmission to quickly turn of the squelch)
  55. **[Enter Menu]+ [5] + [5]** : RPT-DL – Repeater Squelch Tail Eliminator Delay time. (use with Menu 46)
  56. **[Enter Menu]+ [5] + [6]** : DTMF-G – Adjust the gain of the DTMF tones. Selectable from 0-60. 0 being the quietest level and 60 being the loudest modulated DTMF tones.
  57. **[Enter Menu]+ [5] + [7]** : M-GAIN – Adjust the gain the the Microphone. Selectable from 0-127. 0 being the quietest level and 127 being the loudest modulated microphone audio.
  58. **[Enter Menu]+ [5] + [8]** : SKIPTX – Quad Frequency Operation: Randomize transmitting channels - with another corresponding mobile on the same 4 channels transmissions can be spread apart on the four channels in 2 modes. [Off, Skip 1 (Randomizes in between after both transmitting and receiving), Skip 2 (Each PTT Press will systematically go to the next channel (PTT (A), PTT (B), PTT (C), PTT (D), PTT(A), et.)
  59. **[Enter Menu]+ [5] + [9]** : SC-MOD – Automatic Scan Resume Method: Off (Scan cancels with key press, or reboot), PTT-SC (Scanning will resume after transmitting (or other Menu Operations), MEM-SC (Scan Memory during Radio Reboot: If scanning was active when the radio was powered down, the radio wil resume scanning on restart.

(Scanning also resumes after transmitting or other Menu Operations), PON-SC (Power On Scan: The radio will start scanning upon turning on - no matter what state it was in when powering down. Also the radio will scan after Menu operations or Transmitting)

60. **[Enter Menu]+ [6] + [0]** : RESET – Reset all VFO settings or ALL settings (channels deleted and VFO settings cleared)

# Chapter 4. – Programming

## Frequency Mode vs. Channel Mode

*Switch between Modes by Using the V/M Front Panel Button*

*These two modes have different functions and are often confused.*

**Frequency Mode (VFO)** - Used for a temporary frequency assignment, such as a test frequency or quick field programming if permitted.

**Channel Mode (MR)** - Used for selecting preprogrammed channels.

ALL PROGRAMMING MUST BE INITIALLY DONE IN THE FREQUENCY MODE (VFO) ONLY. FROM THERE YOU HAVE THE OPTION OF ASSIGNING THE ENTERED DATA TO A SPECIFIC CHANNEL FOR ACCESS IN THE CHANNEL MODE

CALL TONES, TX/RX TONES, SQUELCH, AND POWER SETTINGS ARE ADJUSTABLE ON SAVED CHANNELS IN CHANNEL MODE

PROGRAMMING CHANNELS ARE DIFFERENT FROM THE VFO SETTINGS; THE OFFSET SETTINGS ARE NOT STORED, INSTEAD YOU ENTER A TX FREQUENCY DIRECTLY (E.G. 145.000 RX WITH AN OFFSET OF (+) .600 WOULD BE A TX FREQUENCY OF 145.600).

## Ex: Programming a Channel Repeater Offset with CTCSS Tone

EXAMPLE New memory in Channel 99:

RX = 145.000 MHz

TX = 145.600 MHz (This is a (+ .600) Offset)

TX CTCSS tone 123.0

1. Change from Menu to Menu by pressing the [EXIT/AB] button.
2. Set radio to VFO Mode by pressing [V/M]  
*Channel number at the right will disappear.*
3. Menu 45 [M] 9 9 [M] [EXIT] **Deletes Prior Data in channel (Ex. 99)**
4. Menu 13 [M] 123.0 [M] [EXIT] **Selects desired TX encode tone**
5. **Enter RX frequency (Ex. 145000)**
6. Menu 44 [M] 9 9 [M] **Enter the desired channel (Ex 99)**  
➤ [EXIT] **RX has been added**
7. **Enter TX frequency (Ex. 145600)**
8. Menu 44 [M] 9 9 **Enter the same channel (Ex 99)**  
➤ [EXIT] **TX has been added**
9. [V/M] Return to MR Mode. **Channel number will re-appear.**



## Ex. Programming a Simplex Channel with CTCSS tone

EXAMPLE New memory in Channel 99:

RX = 446.000 MHz

TX CTCSS tone 123.0

1. Change from Menu to Menu by pressing the [EXIT/AB] button.
2. Set radio to VFO Mode by pressing [V/M]  
*Channel number at the right will disappear.*
3. Menu 45 [M] 9 9 [M] [EXIT] **Delete Prior Data in channel (Ex. 99)**
4. Menu 13 [M] 123.0 [M] [EXIT] **Select desired TX encode tone (Ex 123 CTCSS)**
  - Use [A/B] to select Upper display -> **Enter RX frequency (Ex. 446000)**
5. Menu 44 [M] 9 9 [M] **Enter the desired channel (Ex 99)**
  - [EXIT] **Channel has been added**
6. [V/M] Return to MR Mode. **Channel number will re-appear.**

# Chapter 5. – Other Settings

## Toggle from High to Low Power

A quick press of the Microphone '#' will alternate power levels from High power to Low power

## Storing an FM Radio Station and Scanning

Use PC software to store FM radio channels names, you can name the FM channel and instead of display the frequency your FM station will display the name. (*software* FM option (FM channels are not stored, only the channel names are)) Press the microphone [\*] Key to scan the FM radio.

## Keypad Lock-out

Hold the microphone [# key] for 2 seconds at standby to turn on/off the keypad lock-out function. (The Lock icon appears, when the radio is locked out)

## PTT ID Setting

1. Use PC software to change PTT-ID code.
2. Set the Menu 18 settings on the radio to select the PTTID signal mode (2Tone, 5Tone, or DTMF),

3. Set the Menu 20 settings to select when the PTTID is transmitted.
4. Set the Menu 21 settings to program the PTTID transmit delay time.
5. When all the settings are set, when you transmit (Press the PTT) The radio will transmit the PTTID.



## DTMF RX Settings



This radio has DTMF coding and decoding. Use the PC software to set the DTMF signal settings first.







## DTMF TX Settings

In two-way radio systems, DTMF is most commonly used for automation systems and remote control. A common example would be in amateur radio repeaters where some repeaters are activated by sending out a DTMF sequence (usually a simple single-digit sequence).

**Table 7.1. DTMF frequencies and corresponding codes**

	1209 Hz	1336 Hz	1477 Hz	1633 Hz
697 Hz	1	2	3	A - 
770 Hz	4	5	6	B - 

852 Hz	7	8	9	C - 
941 Hz	*	0	#	D - 

The BTECH UV-25X2/UV-25X4 / UV-50X2 has a full implementation of DTMF, including the A, B, C and D codes. The numerical keys, as well as the , and , keys correspond to the matching DTMF codes as you would expect. The A, B, C and D codes are located in the , ,  and  keys respectively (†).

**Manually TX DTMF Tones:** To manually send DTMF codes, press the key(s) while holding down the PTT key.

### Automatically TX DTMF Tones:

**Save it to Memory and Transmit:** You can also program a DTMF tone to the saved calling list (requires the PC software) to the one of the 15 Memory call banks in the radio. To transmit select the Pre-set DTMF saved setting on Menu 22 and then press the call key to send the saved DTMF TX tone.

## Remote Stun

**First set the DTMF Remote Stun Tone and Master Control ID in Software:** When your radio receives the DTMF Remote Stun Tone Sequence (Set by software) (Requires Menu 18 and 19 to

accept DTMF signaling) it will command the radio to disable transmitting abilities. The Master ID station must first identify and send the PTTID (set in software as “Master ID”) – once the Master Station identifies itself, the radio is set to receive command tones, if the Monitor Remote Stun tone is received - the radio will no longer be able to transmit. *Both the master ID station and remote stun signal must be set up in software.*

## Remote Kill

**First set the DTMF Remote Kill Tone and Master Control ID in Software:** When your radio receives the DTMF Remote Kill Tone Sequence (Set by software) (Requires Menu 18 and 19 to accept DTMF signaling) it will command the radio to disable transmitting and receiving. The Master ID station must first identify and send the PTTID (set in software as “Master ID”) – once the Master Station identifies itself, the radio is set to receive command tones, if the Monitor Remote Kill tone is received - the radio will no longer be able to transmit or receive. *Both the master ID station and remote stun signal must be set up in software.*

## Remote Revive

**First set the DTMF Remote Revive Tone and Master Control ID in Software:** When your radio receives the DTMF Remote Revive Tone Sequence (Set by software) (Requires Menu 18 and 19 to accept DTMF signaling) it will reactivate the radio after it has been remotely stunned or killed. The

Master ID station must first identify and send the PTTID (set in software as “Master ID”) – once the Master Station identifies itself, the radio is set to receive command tones, if the Monitor Remote Kill tone is received - the radio will revived from a stun/kill command. *Both the master ID station and remote stun signal must be set up in software.*

## Read More About Remote Commands

A In-Depth downloadable PDF is available at: [www.baofengtech.com/support](http://www.baofengtech.com/support) which details Remote commands and how to use them. This Document Explains with examples on how DTMF remote commands are used

### DTMF Receive Settings, Transmit Setting (Call Key)

1. Press [MENU] Key select 18 OPTSIG, press [F] Key select DTMF function.
2. Press [MENU] Key select 22 S-INFO, press [F] Key select pre-code signal group (1-15). (The DTMF Signal must be saved first in the PC software setting under DTMF settings.
3. If properly set up (on Menu 18 and 19), your radio will open the squelch when it receives the required DTMG signal.
4. Press [Call] Key to send the same DTMF you have selected in Menu 22.

### 2TONE Receive Settings, Transmit Setting (Call Key)

1. Press [MENU] Key select 18 OPTSIG, press [F] Key select 2TONE function.
2. Press [MENU] Key select 22 S-INFO, press [F] Key select pre-code signal group (1-15). (The 2Tone Signal must be saved first in the PC software setting under 2TONE settings)
3. If properly set up (on Menu 18 and 19), your radio will open the squelch when it receives the required 2TONE signal.
4. Press [Call] Key to send the same 2TONE you have selected in Menu 22.

## **5Tone Receive Settings, Transmit Setting (Call Key)**

1. Press [MENU] Key select 18 OPTSIG, press [F] Key select 5TONE function.
2. Press [MENU] Key select 22 S-INFO, press [F] Key select pre-code signal group (1-15). (The 5Tone Signal must be saved first in the PC software setting under 5TONE settings)
3. If properly set up (on Menu 18, and 19), your radio will open the squelch when it receives the required 5TONE signal.
4. Press [Call] Key to send the same 5TONE you have selected in Menu 22.

## Scanning modes

The scanner is configurable to one of three ways of operation: Time, carrier or search, each of which is explained in further details in their respective section below.

### Procedure 5.1. Setting scanner mode

1. Press the **MENU** key to enter the menu.
2. Enter “17” on your numeric keypad to come to scanner mode.
3. Press the **MENU** key to select.
4. Use the **▲** and **▼** keys to select scanning mode.
5. Press the **MENU** key to confirm and save.
6. Press the **EXIT** key to exit the menu.

## Time operation

In Time Operation (TO) mode, the scanner stops when it detects a signal, and after a factory pre-set time out, it resumes scanning.

## Carrier operation

In Carrier Operation (CO) mode, the scanner stops when it detects a signal, and after a factory preset time with no signal it resumes scanning.









## Search operation

In Search Operation (SE) mode, the scanner stops when it detects a signal.

To resume scanning you must press and hold the  key again.

## SKIP Scanning Channels

You can configure channels to be added or removed from the scanning list on the fly.

1. Press the  key to enter the menu.
2. Enter Menu Item 16 on your numeric keypad to come to scanning add mode.
3. Press the  key to select.
4. Use the  and  keys to select if the channel will be added or removed from the scanning list. The change will apply to the current channel selected
5. Press the  key to confirm and save.
6. Press the  key to exit the menu.

## Scanning a Frequency Range (VFO Mode)

The UV-5X3 can scan a user selected frequency range

1. Press and Hold  for about 2 seconds
2. The Display will show: **RANGE ---:---**
3. Enter the Frequency Range (In MHz) Desired
4. *Example: 144:145*
5. The Radio will scan the frequency range from 144.000MHz-145.9975MHz According To Your Frequency Step (See Menu 1 Description)

## Tone Scanning

### Scanning for CTCSS and DCS Tones/Codes

*Scanning for a CTCSS tone or DCS code can be done while Frequency Mode (VFO) or Channel Mode (MR) is selected. Only when VFO mode is selected, can the detected tone/code be saved to menu 11/10.*



*CTCSS tone and DCS code scanning mode can be accessed with or without a signal being present. The scanning process itself only occurs while a signal is being received.*

*Not all repeaters requiring a CTCSS tone or DCS code for access will transmit one back. In that case, the transmitter of a station that can access the repeater would need to be*

*scanned. In other words: this would be done by listening to stations on the repeater's input frequency.*

## Scanning for CTCSS Tone

*(ACTIVE SIGNAL REQUIRED)*

1. Press the **MENU** key to enter the menu.
2. Enter **1STEP 1STEP** on your numeric keypad to come to Menu 11: R-CTCS
3. Press the **MENU** key to select.
4. Press the **\*SCAN** to begin CTCSS scanning

A flashing "CT" will be in the left status display to indicate the radio is in CTCSS scanning mode. In this mode, whenever the radio is receiving an RF signal on the selected MR channel or VFO frequency, the lower display will cycle through the CTCSS tones as they are being tested. Once the frequency of the received CTCSS tone is determined, the "CT" indicator will stop flashing.

Press the **MENU** key to save the scanned tone into memory (VFO Mode Only) then press the **EXIT** key to exit the menu.



*Don't forget to set VFO menu 11 back to OFF when the CTCSS tone is no longer required.*

## Scanning for a DCS tone

*(ACTIVE SIGNAL REQUIRED)*

1. Press the **(MENU)** key to enter the menu.
2. Enter **(1STEP) (0SQL)** on your numeric keypad to come to Menu 10: R-DCS
3. Press the **(MENU)** key to select.
4. Press the **(\*SCAN)** to begin DCS scanning

A flashing "DCS" will be in the left status display to indicate the radio is in DCS scanning mode. In this mode, whenever the radio is receiving an RF signal on the selected MR channel or VFO frequency, the lower display will cycle through the DCS codes as they are being tested. Once the bits of the received DCS code are determined, the "DCS" indicator will stop flashing.

Press the **(MENU)** key to save the scanned tone into memory (VFO Mode Only) then press the **(EXIT)** key to exit the menu.



*Don't forget to set VFO menu 10 back to OFF when the DCS tone is no longer required.*

## Dual, Tri, and Quad Watch (TMR)

In certain situations, the ability to monitor two, three or even four channels at once can be a valuable asset.

The BTECH UV-25X2, UV-25X4, and UV-50X2 features Dual, Tri, and Quad Watch functionality with the ability scan between two-four frequencies at a fixed intervals and to lock the transmit frequency to one of the four channels it monitors

1. Press the **MENU** key to enter the menu.
2. Enter “0” on the numeric keypad to get to the TMR Watch Settings
3. Press **MENU** to select which channels are monitored (See Appendix A).
4. Use the **▲** and **▼** keys to enable or disable.
5. Press the **MENU** key to confirm.
6. Press the **EXIT** key to exit the menu.

Due to the way the BTECH UV-25X2 / UV-25X4 / UV-50X2 are constructed, whenever one of the A, B, C, or D Frequencies (VFO/MR) goes active, it will default to transmit on that channel for the time you have selected on Menu 52 – this can be turned off and explained below:

### Locking the Default transmit channel

1. Press the **MENU** key to enter the menu.
2. Enter 52 on the numeric keypad to get to TMR-AB.
3. Press **MENU** to select.
4. Select off, to turn off the TMR switching time.
5. Press the **MENU** key to confirm.
6. Press the **EXIT** key to exit the menu.
7. The radio will now only transmit on the Main channel selected (The Main Frequency indicator arrow will be pointing at the display set as primary)

## Chapter 6. - Selective calling

Some times when you're working with larger groups of people using the same channel, things can get very crowded, very fast. To minimize this problem, several methods of blocking out unwanted transmissions on your frequency have developed. In general, there are two forms of selective calling in two-way radio systems: Group calling, and individual calling.

Group calling, as the name suggest, is a one-to-many form of communication. Every radio in your working group is configured the same way and any radio will make contact with every other radio in the group.

Individual calling, some times also known as paging, is a one-to-one form of communication. Every radio is programmed with a unique ID code. And only by sending out a matching code can you get that radio to open up to your transmissions.

The BTECH X-SERIES MOBILES features three additional ways of group calling  
**(2TONE, 5TONE, AND DTMF CALLING ARE FOUND IN CHAPTER 5):**

- CTCSS
- DCS
- Tone-burst (1000Hz, 1450Hz, 1750Hz, 2100Hz)

*Using these features does NOT mean that others won't be able to listen in on your transmissions.*



*They only provide a method to filter out unwanted incoming transmissions. Any communications made while using these features will still be heard by anyone not employing filtering options of their own.*

*You can change the CTCSS or DCS settings while in memory (MR) mode.*

CTCSS and 1750Hz tone-burst are also popular methods among amateur radio operators to open up repeaters.

## CTCSS

CTCSS is set with menus 11 R-CTCS and 13 T-CTCS.

### Procedure 8.1. CTCSS setup how-to

1. Press the **(MENU)** key to enter the menu.
2. Enter **(1STEP)** **(1STEP)** on the numeric keypad to get to receiver CTCSS.
3. Press **(MENU)** to select.



4. Enter desired CTCSS sub-tone frequency in hertz on the numeric keypad.
5. Press **(MENU)** to confirm and save.
6. Enter **(1STEP)** **(3SAVE)** on the numeric keypad to go to transmitter CTCSS.
7. Press **(MENU)** to select.
8. Enter desired CTCSS sub-tone frequency in hertz on the numeric keypad. Make sure it's the same frequency as that you entered for receiver CTCSS.
9. Press **(MENU)** to confirm and save.
10. Press **(EXIT)** to exit the menu system.

To turn CTCSS off, follow the same procedure but set it to off with the **(0SQL)** key instead of selecting a CTCSS sub-tone frequency.

For more information see the section called “11 R-CTCS - Receiver CTCSS” and the section called “13 T-CTCS - Transmitter CTCSS” in Appendix B, Menu definitions.

## DCS

DCS is set with menus 10 R-DCS and 12 T-DCS.

For a complete list of available DCS codes, see Table C.1, “DCS Codes” in Appendix C, *Technical specifications*.

### Procedure 8.2. DCS setup how-to

1. Press the **MENU** key to enter the menu.
2. Enter **1STEP 0SQL** on the numeric keypad to get to receiver DCS.
3. Press **MENU** to select.
4. Scroll to the desired DCS code on the numeric keypad.
5. Press **MENU** to confirm and save.
6. Enter **1STEP 2TXP** on the numeric keypad to go to transmitter DCS.
7. Press **MENU** to select.
8. Scroll to the desired DCS code on the numeric keypad. Make sure it's the same code as that you entered for receiver DCS.
9. Press **MENU** to confirm and save.
10. Press **2TXP** to exit the menu system.

To turn DCS off, follow the same procedure but set it to off with the **0SQL** key instead of selecting a DCS code.

For more information see the section called “10 R-DCS - Receiver DCS” and the section called “12 T-DCS - Transmitter DCS” in Appendix B, *Menu definitions*.

## 1000Hz, 1450Hz, 1750Hz, 2100Hz Tone-burst

To send out a tone-burst; you simultaneously will press the PTT key while holding down the Call button.

To configure which Tone Burst is transmitted select the Tone Burst desired from Menu Item 50 (REP-S)

PTT + **CALL** = Selected Tone Burst (Selectable in Menu 50: REP-S)

# Part III. How-to and setup guides.

*Part three covers is a collection of how-to documents to help you set up your radio for specific working environments.*

**CHAPTER 7 REPEATERS**

**CHAPTER 8 APPLICATION SPECIFIC SETUP**

**CHAPTER 9 CUSTOMIZATION**

## Chapter 7. - Repeaters

A radio repeater is an automated transceiver in a fixed location. Usually mounted high up on hilltops or on tall buildings, but sometimes they operate within buildings for internal use. A repeater takes one signal and relays it, usually after amplifying it by orders of magnitude.

Whether you're a commercial (business or government) user or an amateur radio operator, chances are you'll be dealing with a repeater system sooner or later. To find out what settings to use to use your local repeater, ask your employer or someone at your local amateur radio organization for details.

A common type of repeater is the duplex repeater. In a duplex repeater system, the repeater transmits and receives simultaneously, but on different frequencies. To utilize this type of repeater, your radio has to be capable of transmitting and receiving on different frequencies on the same memory channel. How you use this kind of repeater is by setting the receive frequency of your radio to the output frequency of the repeater, and the transmit frequency of your radio to the input frequency of the repeater. Often times, the transmit frequency to use isn't explicitly stated, but rather an offset relative your receive frequency is specified. This is conveniently by specifying offset rather than transmit frequency. (Example 145.000MHz Receive with .600MHz transmit is a transmit Channel of 145.600MHz)

*SFT-D and OFFSET only function in VFO mode.*



*MR mode uses and stores the RX frequency and the TX frequency directly (see Chapter 4)*

The following instructions assume that you know what transmit and receive frequencies your repeater employs, and that you're authorized to use it.

1. Set the radio to Frequency (VFO) mode with the **VFO/MR** key.
2. Enter the repeater's output (your receiving) frequency by either using the **▲** and **▼** keys, or by entering it directly on the numerical keypad.
3. Press the **MENU** key to enter the menu.
4. Enter Menu 47 to get to frequency offset.
5. Press **MENU** key to select.
6. Use the **▲** and **▼** keys and the numerical keypad to enter the specified frequency offset. See the section called "26 OFFSET - Frequency shift amount" for details.
7. Press **MENU** to confirm and save.
8. Enter Menu 46 on the numeric keypad to get to offset direction.
9. Use the **▲** and **▼** keys to select +(positive) or -(negative) offset.
10. Press **MENU** to confirm and save.

11. Optional:

- a. Save to memory, see Chapter 4 for details.
- b. Set up CTCSS; see the section called “CTCSS” for details.

12. Press **EXIT** to exit the menu.

If everything went well, you should be able to make a test call through the repeater. If you're experiencing problems making a connection to the repeater, check your settings and/or go through the procedure again.

If you're still unable to make a connection, contact the person in charge of the radio system with your employer or your local amateur radio club, as the case may be.



*If you for some reason want to listen to the repeater's input frequency instead, press **\*SCAN** momentarily and you'll reverse your transmit and receive frequencies.*

*This is indicated in the LCD on the radio with an R in the top row, next to the + and - for the offset direction.*

# Chapter 8. - Application Specific Setup

## Commercial Radio Setup

PLMR users in the United States are mandated to move to 12.5 kHz narrowband communication in the 150-174 MHz VHF and 421-512MHz UHF bands by January 1, 2013.

Follow these instructions to set your radio to Narrowband mode:



*This section is only true for VFO mode.*

*WN is settable on a per channel basis and has to be set prior to storing a channel.*

*Once a channel has been programmed, the channel must be deleted and reprogrammed to change the WN setting.*

1. Press the **VFO/MR** key to enter frequency mode.
2. Press the **MENU** key to enter the menu.
3. Enter Menu Item 7 on the numerical keypad.
4. Press **MENU** to select.
5. Use the **▲** and **▼** keys to select between Wide and Narrow ("Narr").
6. Press **MENU** to confirm and save
7. Press **EXIT** to exit the menu.



To find out what other channels and features needed, please contact your employer.

## Amateur Radio Setup

In contrast with Commercial radio operators, who often need very specific requirements to be compatible with a very specific radio implementation, Amateur radio operators tend to need the broadest possible settings in order to be compatible with as many systems as possible. This basically implies turning all the fancy features that you typically might need for a commercial setup off.

In a typical Amateur radio setup the following settings would be recommended:

- Set bandwidth to Wide (menu item 7).
- Turn Receive DCS and CTCSS off (menu items 10 through 11).
- Turn off Squelch Tail Elimination (STE) features (menu items 53 through 54).
- Turn roger beep (ROGER) off (menu item 25).

For further information see Appendix A, *Menu definitions*

## FRS, GMRS, MURS, PMR446



*You may be tempted to use FRS, GMRS, MURS (in the USA) or PMR446 (in Europe) frequencies. Do note however that there are restrictions on these bands that make this transceiver illegal for use.*

# Chapter 9. - Customization

## Display

The LCD on the BTECH Mobiles are backlit multi-color LEDs, the color of which can be pre-set from the menu system into a variety of colors.

To change the colors, follow these steps:

1. Press the (MENU) key to enter the menu.
2. Enter one of the following on your numeric keypad:
  - a. 33 to change the main LCD text color.
  - b. 34 to change the main LCD background color.
  - c. 35 to change the menu LCD text color.
  - d. 36 to change the menu LCD background color.
  - e. 37 to change the status bar icon's color.
  - f. 38 to change the status bar (top bar) background color.
  - g. 39 to change the signal bar icon's color.
  - h. 40 to change the signal bar (bottom bar) background color.
  - i. 41 to change the receiving channel text color.

- j. 42 to change the transmitting channel text color.
3. Press **MENU** key to select.
4. Use the **▲** and **▼** keys to pick the desired color.
5. Press **MENU** to confirm and save.
6. Press **EXIT** to exit the menu.

## Sync Display Channels

To sync channels on the display (simultaneously display channel name and frequency), follow these steps:

1. Press the **(MENU)** key to enter the menu.
2. Enter 32 on your numeric keypad to come to the Sync Menu
3. Press **(MENU)** key to select.
4. Use the **(▲)** and **(▼)** keys to select:
  - a. AB –To sync A/B Displays
  - b. CD – To sync C/D Displays
  - c. AB+CD – To sync both A/B and C/D Displays
5. Press **(MENU)** to confirm and save.
6. Press **(EXIT)** to exit the menu.

Use SYNC in Conjunction with Menus 27,28,29 & 30 to coordinate what is displayed on each line (Name, Frequency, or Channel Number) –See *Appendix B Menu definitions*



## Appendix A. - Menu definitions

0	TMR	Transmit Multi Receive	M+A	This mode selects what displays are monitored in the background besides the primary selected channel. You can mix and match between all or partial channels to allow dual, tri, and quad watch  Selected Memory + Displays (A,B,C,D)  M = Selected Memory A = Display A B = Display B C = Display C D = Display D
			M+B	
			M+C	
			M+D	
			M+A+B	
			M+A+C	
			M+A+D	
			M+B+C	
			M+B+D	
			M+C+D	
			M+A+B+C	
			M+A+B+D	
M+A+C+D				
M+B+C+D				
A+B+C+D				
1	STEP	Frequency Step Size Setup	2.5 to 25. kHz	2.5, 5, 6.25, 10, 12.5, 25 kHz
2	SQL	Squelch Level	00 > 09	10 squelch levels 00 = minimum / normally open
3	TXP	Transmit Power	High	Full Power
			Low	Reduced Power
4	AUTOLK	Auto Keypad Lock	ON	Keypad Auto Lock Enabled
			OFF	Keypad Auto Lock Disabled

5	TOT	TX Time Out Timer	15 > 600 secs	15 second steps
6	APO	Auto Power Off	30, 60 > 300 minutes	Time Set that radio will Power Off after last signal received.
			OFF	Turn off APO Option
7	WN	Bandwidth	Wideband	25.0 kHz
			Narrowband	12.5 kHz
8	ABR	Unused Setting		
9	BEEP	Keypad Voice Prompt	ON / OFF	Turn ON / OFF keypad voice prompt
10	R-DCS	Receive - Digital Coded Squelch	D023N > D754I	Squelch opens when proper DCS code is detected
			OFF	No DCS code required
11	R-CTCS	Receive - Analog Tone Squelch	67.0 > 254.1 Hz	Squelch opens when proper CTCSS tone detected
			OFF	No CTCSS tone required
12	T-DCS	Transmit - DCS Code	D023N > D754I	Transmits specified code
			OFF	No DCS code transmitted
13	T-CTCS	Transmit - CTCSS Code	67.0 > 254.1 Hz	Transmits specified tone
			OFF	No CTCSS tone transmitted



14	DTMFST	Determines when DTMF codes are heard through speaker	OFF	No DTMF tone heard
			DS-ST	Only manually keyed DTMF codes are heard
			ANI-ST	Only automatically keyed DTMF codes are heard
			DT-ANI	All DTMF codes are heard
15	BCL	Busy Channel Lockout	ON	Prevents transmit if active signal on the channel
			OFF	No lockout
16	SC-ADD	Add Scan Channel	ON	Add channel to scan list
			OFF	Remove channel from scan list
17	SC-REV	Scan Resume Method	TO	(Time Operation) Scan stops when signal detected. The scan resumes after approximately 5 seconds (even if the channel is still active).
			CO	(Carrier Operation) Scan stops when signal detected. Scan resumes when signal disappears.
			SE	(Search Operation) Scan stops when signal detected. Scanning will not resume.
18	OPTSIG	Optional Signaling	OFF	No optional signaling
			DTMF	DTMF signaling selected
			2TONE	2TONE signaling selected
			5TONE	5TONE signaling selected
19	SPMUTE	Speaker Mute Settings	QT	Squelch opens for CTCSS/DCS tones only.

			AND	Squelch opens when CTCSS/DCS tone is recognized along with the optional signaling.
			OR	Squelch opens when either the CTCSS/DCS tone OR the optional signaling is recognized.
20	PTT-ID	PTT ID - When to send	OFF	Do not send
			BOT	Send at Beginning of Transmission
			EOT	Send at the End of Transmission
			BOTH	Send at both Beginning and End
21	PTT-LT	PTT ID - Transmit Delay	0 > 30	Set Delay Time before transmitting PTT-ID
22	S-INFO	Auto Group Dialing	Group Signal Code	1 > 15
			Memory	Can only be set with software
23	EMC-TP	Alarm Mode	ALARM	Turn on Alarm sound
			ANI	Send Alarm code and ID code
			BOTH	Both of the above
			OFF	Alarm Mode Completely Disabled
24	EMC-CH	Alarm Channel	000 > 199	Specified Alarm Channel
25	SIG-BP	Signal Beep	ON	Pager Ring at Reception of Matching 2Tone/5Tone/DTMF
			OFF	Tone OFF
26	CHNAME	Channel Name Edit	In Channel Mode, edit the Current Name	
27	CA-MDF	Channel A	FREQ	In Channel Mode, display the selected format in

		Display Mode	CH	display A
			NAME	
28	CB-MDF	Channel B	FREQ	In Channel Mode, display the selected format in display B
		Display Mode	CH	
			NAME	
29	CC-MDF	Channel C	FREQ	In Channel Mode, display the selected format in display C
		Display Mode	CH	
			NAME	
30	CD-MDF	Channel D	FREQ	In Channel Mode, display the selected format in display D
		Display Mode	CH	
			NAME	
31	LANGUA	Language	English	Screen Prompts Display
			Chinese	
32	SYNC	Display Sync	OFF	Separate A/B/C/D channel display.
			AB	Synchronizes display AB, CD, or AB+CD
			CD	This allows the upper display to show channel name while the lower shows the frequency. You can sync the top 2, bottom 2, or both sections simultaneously
			AB + CD	
33	MAINFC	MAIN LCD Display	Select Color	BLACK, WHITE, RED, BLUE, GREEN, YELLOW,

		Foreground Color (Text)		INDIGO, PURPLE, GRAY
34	MAINBC	MAIN LCD Display	Select Color	BLACK, WHITE, RED, BLUE, GREEN, YELLOW, INDIGO, PURPLE, GRAY
		Background Color		
35	MENUFC	On Screen Menu	Select Color	BLACK, WHITE, RED, BLUE, GREEN, YELLOW, INDIGO, PURPLE, GRAY
		Foreground Color (Text)		
36	MENUBC	On Screen Menu	Select Color	BLACK, WHITE, RED, BLUE, GREEN, YELLOW, INDIGO, PURPLE, GRAY
		Background Color		
37	STA-FC	Status (Top) Bar Display	Select Color	BLACK, WHITE, RED, BLUE, GREEN, YELLOW, INDIGO, PURPLE, GRAY
		Foreground Color (Text)		
38	STA-BC	Status (Top) Bar Display	Select Color	BLACK, WHITE, RED, BLUE, GREEN, YELLOW, INDIGO, PURPLE, GRAY
		Background Color		
39	SIG-FC	Bottom Bar Display	Select Color	BLACK, WHITE, RED, BLUE, GREEN, YELLOW, INDIGO, PURPLE, GRAY
		Foreground Color (Text)		
40	SIG-BC	Bottom Bar Display	Select Color	BLACK, WHITE, RED, BLUE, GREEN, YELLOW, INDIGO, PURPLE, GRAY
		Background Color		
41	RX-FC	Main LCD Receiving Color	Select Color	BLACK, WHITE, RED, BLUE, GREEN, YELLOW, INDIGO, PURPLE, GRAY
		Foreground Color (Text)		
42	TX-FC	Main LCD TX Color	Select Color	BLACK, WHITE, RED, BLUE, GREEN, YELLOW, INDIGO, PURPLE, GRAY
		Foreground Color (Text)		
43	TXDISP	Transmit Display	POWER	Display Power Level on Bottom Graph
			MIC-V	Display Mic Audio Level on Bottom Graph

44	MEM-CH	Memorize Channel	000 > 199	Indicates channel number to be stored.
45	DEL-CH	Delete Channel	000 > 199	Indicates channel number to be deleted.
46	SFT-D	Frequency Shift Direction	OFF	No Offset (simplex)
			+	Plus frequency shift
			-	Minus frequency shift
47	OFFSET	Frequency Shift Offset Amount	00.00 > 69.99	Frequency shift in MHz
48	ANI	ANI ID Code	Can only be set with software	
49	ANI-L	ANI Length	3, 4, 5	Length of ANI ID code
50	REP-S	Repeater Activation Tone	1000Hz 1450Hz 1750Hz 2100Hz	Audible tone for repeater activation
51	REP-M	Repeater Forwarding Mode (X-Band Repeater with 2 BTECH Mobiles) –  See Detailed PDF Guide at: <a href="http://baofengtech.com/support">baofengtech.com/support</a>	OFF	Function OFF
			CARRI	Forward after receiving Carrier
			CTDCS	Forward after receiving correct CTDCS
			TONE	Forward after receiving correct mono audio (Menu 42)
			DTMF	Forward after receiving assigned DTMF code (ANI)
52	TMR-MR	TMR - Return Time Delay to Primary Channel; Sets the PTT to the last received transmission channel. Time delay selectable	OFF	Function OFF - Transmits always on Primary Channel
			1 > 50 seconds	This is the delay time before returning to the primary channel after secondary signal is clear.

53	STE	Squelch Tail Elimination	OFF	Function OFF
		Requires both radios have function ON.	ON	Eliminates squelch tail at end of transmission.
54	RP-STE	Repeater Squelch Tail Elimination	OFF	Function OFF
		Requires a repeater using this function.	1 > 10	Delay Time
55	RPT-DL	Repeater squelch tail delay.	OFF	Function OFF
			1 > 10	Delay Time
56	DTMF-G	DTMF Gain /	0 > 60	0 = Lowest Audio Gain
		Audio Level		60 = Highest Gain
57	MIC-G	Microphone Gain /	0 > 127	0 = Lowest Audio Gain
		Audio Level		127 = Highest Gain
58	SKIPTX	Quad Frequency Operation: Randomize transmitting channels - with another corresponding mobile on the same 4 channels transmissions can be spread apart on the four channels in 2 modes.	OFF	
			SKIP1	Randomizes in between after both transmitting and receiving, Requires both a received and a transmission before going to another random frequency
			SKIP2	Alternates transmitting on A,B,C,D - each PTT Press the radio will transmit on the next channel in order of their display (A-B-C-D-Repeat)
59	SC-MOD	Automatic Scan Resume Method	OFF	Scan is disabled with a Radio Reboot, or by Pressing a Menu Key / PTT
			PTT-SC	Scanning will resume after transmitting (or other

				Menu Operations)
			MEM-SC	Scan Memory during Radio Reboot: If scanning was active when the radio was powered down, the radio wil resume scanning on restart. (Scanning also resumes after transmitting or other Menu Operations)
			PON-SC	Power On Scan: The radio will start scanning upon turning on - no matter what state it was in when powering down. Also the radio will scan after Menu operations or Transmitting
60	RESET	Initialize to Factory Defaults	VFO	Menu Initialization
			ALL	Menu and Channel Initialization

## FIND TUTORIALS, SUPPORT AND MORE

<https://www.facebook.com/BaoFeng.Tech.Radio> 

<https://plus.google.com/+Baofengtechradio> 

<https://www.youtube.com/c/Baofengtechradio> 



## Appendix B. - Technical specifications

### General

Specification	Value
Frequency Range (MHz)	65-108 (Rx only): UV-25X2, UV-50X2, UV-25X4 136-174 (Rx/Tx): UV-25X2, UV-50X2, UV-25X4 220-260 (Rx/Tx) US/Asia: UV-25X4 350-390 (Rx/Tx) EU/Asia: UV-25X4 400-520 (Rx/Tx): UV-25X2, UV-50X2, UV-25X4
Memory channels	200
Frequency stability	2.5ppm
Frequency step (kHz)	2.5K/5.0K/6.25K/10.0K/12.5K/25.0K
Squelch Setup	CARRIER / CTCSS / DCS / 5Tone / 2TONE / DTMF
Antenna impedance	50 Ohm
Operating temperature	-20°C to +60°C
Supply voltage	13.8V DC±15%: 20A Peak UV-50X2 --- 7A Peak UV-25X2, UV-25X4
Dimension	UV-25X2/UV-25X4: 4(W) x 1.85 (H) x 5 (D)in; 1lb UV-50X2: 5.7(W) x 1.85 (H) x 7.5 (D)in; 2.2lb
Operating Temperature	-5°F - +140°F

## Receiver

### *Receiver specifications*

	Broadband	Narrow band
Sensitivity	$\leq 0.25\mu\text{V}$	$\leq 0.35\mu\text{V}$
Channel choice	$\geq 70\text{dB}$	$\geq 60\text{dB}$
Intermodulation	$\geq 65\text{dB}$	$\geq 60\text{dB}$
Spurious Rejection	$\geq 70\text{dB}$	$\geq 70\text{dB}$
Audio response	+1~-3dB (0.3-3KHz)	+1~-3dB (0.3~2.55KHz)
Signal to noise ratio	$\geq 45\text{dB}$	$\geq 40\text{dB}$
Audio Distortion	$\leq 5\%$	
Audio output power	$\geq 2\text{W}@10\%$	

## Transmit

	Broadband	Narrow band
Output power	25W (20W) / 10W (7W) (VHF (UHF)) - UV-25X2/UV-25X4 50W/ 10W - UV-50X2	
Modulation Mode	16K $\phi$ F3E	11K $\phi$ F3E
Channel Power	$\geq 70\text{dB}$	$\geq 60\text{dB}$
Signal to noise ratio	$\geq 40\text{dB}$	$\geq 36\text{dB}$
Parasitic harmonic	$\geq 60\text{dB}$	$\geq 60\text{dB}$
Audio response	+1~-3dB(0.3-3KHz)	+1~-3dB (0.3-2.55KHz)
Audio distortion	$\leq 5\%$	

